



# SpeedFence (SUPERBARRIER)

SUPERIOR EDGE PROTECTION

# WHAT IS SUPERBARRIER

SuperBarrier is an engineered edge protection system with self supporting counter weight base which is extremely quick to install and relocate.

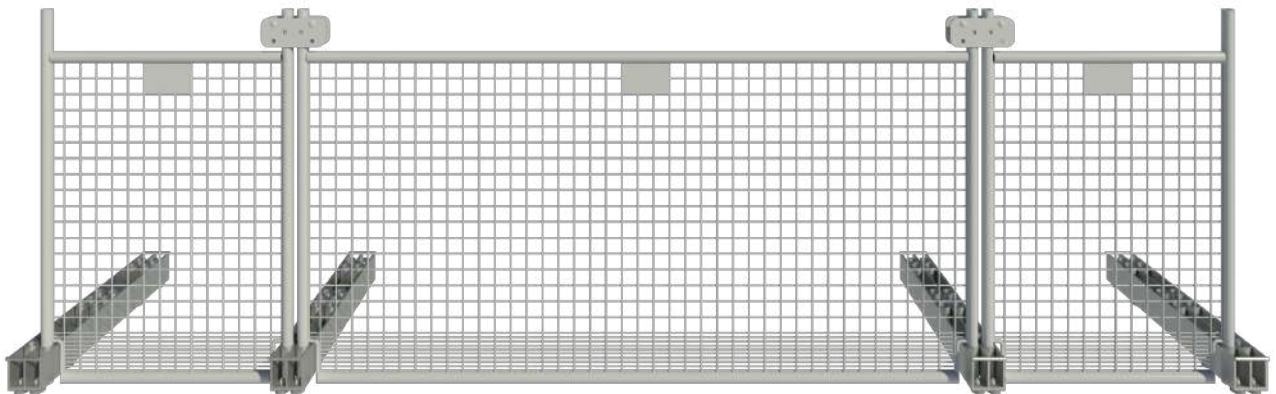

**no messy components**

**easy assembly**

# Components

---

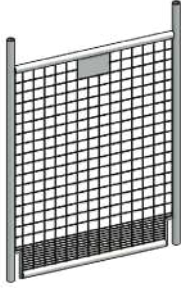

## B08

800mm SuperBarrier Panel

50 x 50 x 4 mm mesh and kickboard.

Length: 800 mm

Height: 1100 mm

Weight: 10 kg

---

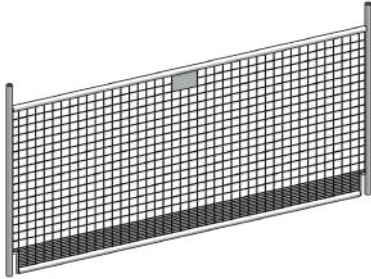

## B21

2100mm SuperBarrier Panel

50 x 50 x 4 mm mesh and kickboard.

Length: 2100 mm

Height: 1100 mm

Weight: 20 kg

---

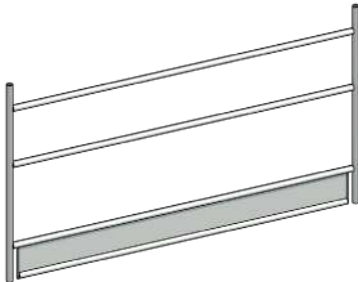

## B2H

2000mm Access Panel

Handrail and kickboard.

Length: 2000 mm

Height: 1100 mm

---



## RMB

Rubber Metal Base

RMB has 14 positions to insert B08 or B21. All RMB have 8 rubber (foot pads) for better grip.

**Weight:** 18 Kg

---



## BBP

Bolt Down Base Plate

BBP can be bolted to concrete, timber, ply or any other material using 12 mm anchor bolt.

**Weight:** 2.3 Kg

---

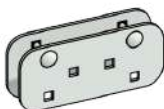

## CLP

Clip Bracket with 6 x bolt holes

Bracket used for clamping 2 or more SuperBarrier panels together. Comes with 2 x M10 x 65 mm cuphead bolts and nuts.

**Weight:** 1.5 Kg

---

# HOW TO INSTALL

## BRIEF INSTRUCTION TO ASSEMBLE SUPERBARRIER

### 1. Components in this demonstration kit

**1.1** Barrier 2100 mm [B21]  
Qty: 5

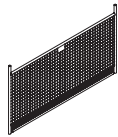

**1.2** Barrier 800 mm [B08]  
Qty: 1



**1.3** Rubber Metal Base [RMB]  
Qty: 7

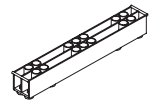

**1.4** Clip (with 2 x nut/bolt) [CLP]  
Qty: 5



### 2. Assembly Instruction

**2.1** Lay 4 B21 barrier in a straight line, one B21 at 90° at the other end of B21

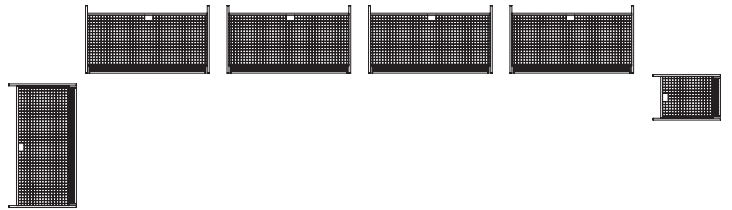

**2.2** Place Rubber Metal Bases (RMB) alongside barriers as shown

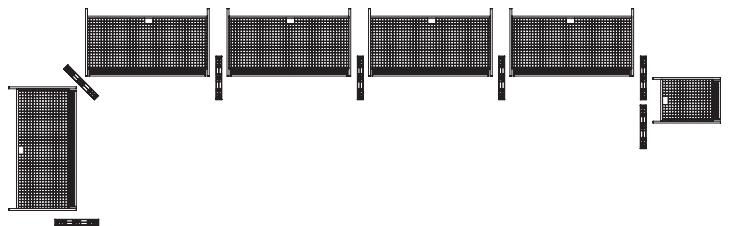

**2.3** Stand up B21 barriers and place the posts of the B21 barrier into the middle pipes of each Rubber Metal Base (RMB)



**2.4** B21 and B08 barrier at the end to be turned upside down with the kickboard up to show example that all barriers can be installed either up or down to get extra height or to straddle the Rubber Metal Base (see Section A and B)

**2.5** Place clip (CLP) level top of rail and tighten with a ratchet, spanner or cordless wrench with 17 mm socket (see Detail C)

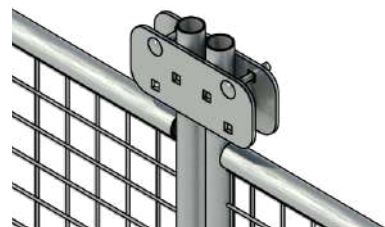

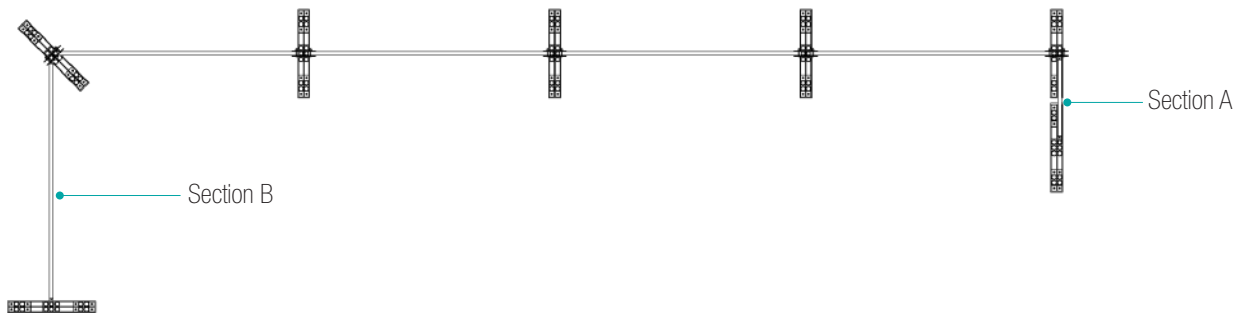

## PLAN

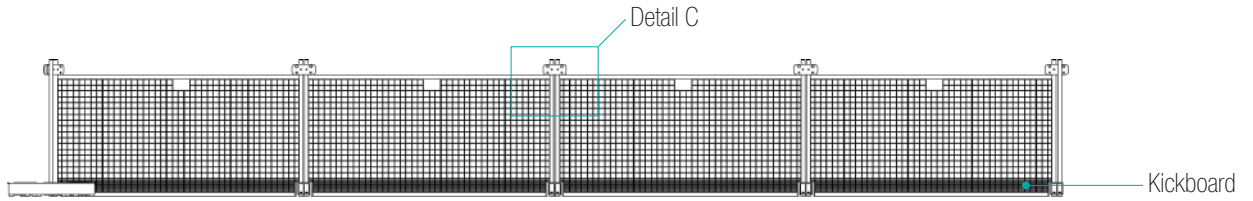

## ELEVATION

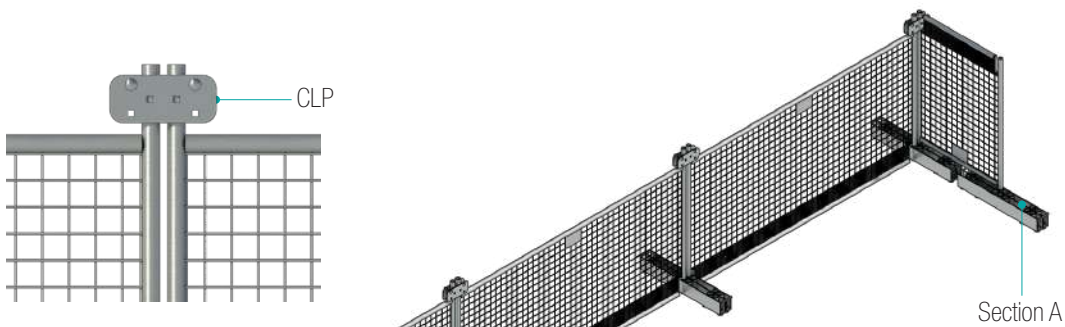

## DETAIL C

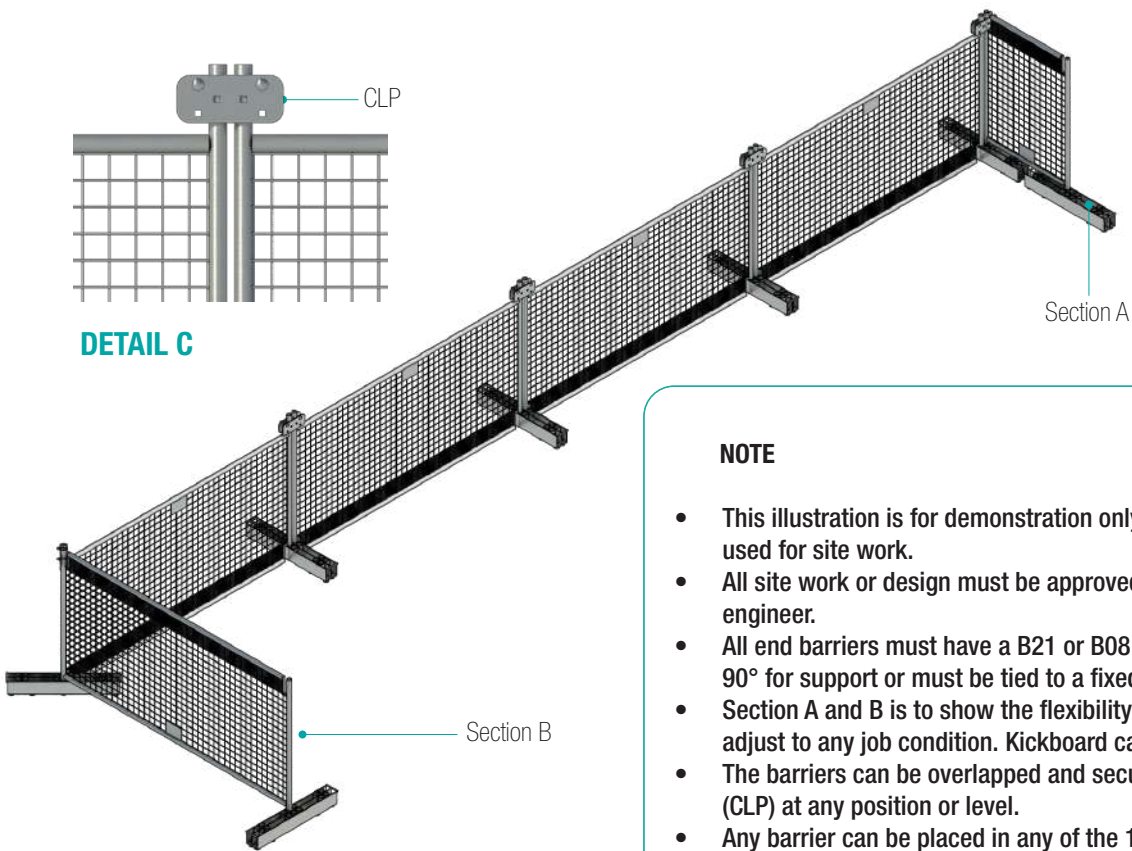

### NOTE

- This illustration is for demonstration only. It is not to be used for site work.
- All site work or design must be approved by the site engineer.
- All end barriers must have a B21 or B08 Barrier return at 90° for support or must be tied to a fixed structure.
- Section A and B is to show the flexibility of SuperBarrier to adjust to any job condition. Kickboard can be up or down.
- The barriers can be overlapped and secured with the clips (CLP) at any position or level.
- Any barrier can be placed in any of the 14 RMB pipe inserts with the kickboard up or down, in straight or circular line.

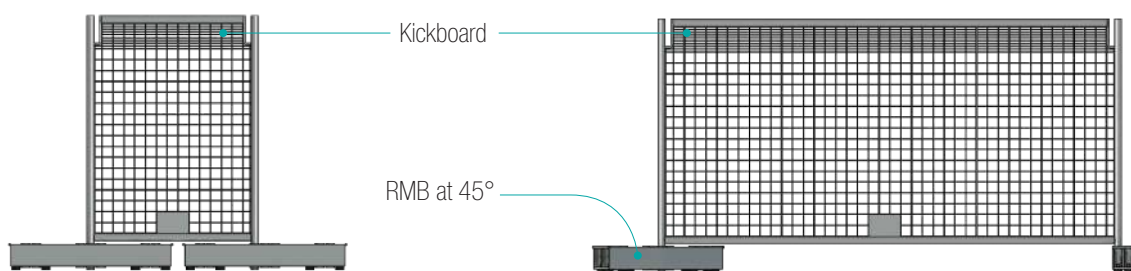

## SECTION A

Shown with B08 Barrier Kickboard up to straddle or 'jump over' Rubber Metal Base (RMB)

## SECTION B

Shown with B21 Barrier kickboard up

# TYPICAL LAYOUTS

THE FOLLOWING LAYOUTS ARE INDICATIVE ONLY

## LAYOUT 1.1

STANDARD LAYOUT - MIDDLE OF RMB



## PLAN

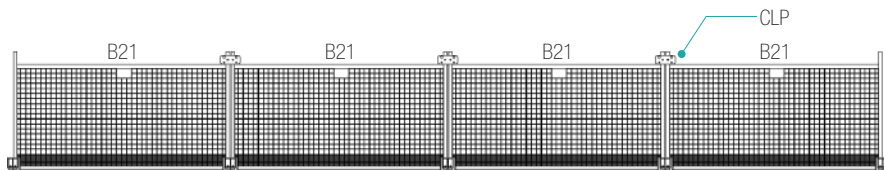

## ELEVATION



## LAYOUT 1.2

ON END OF RMB AND OVERLAP AT WALL

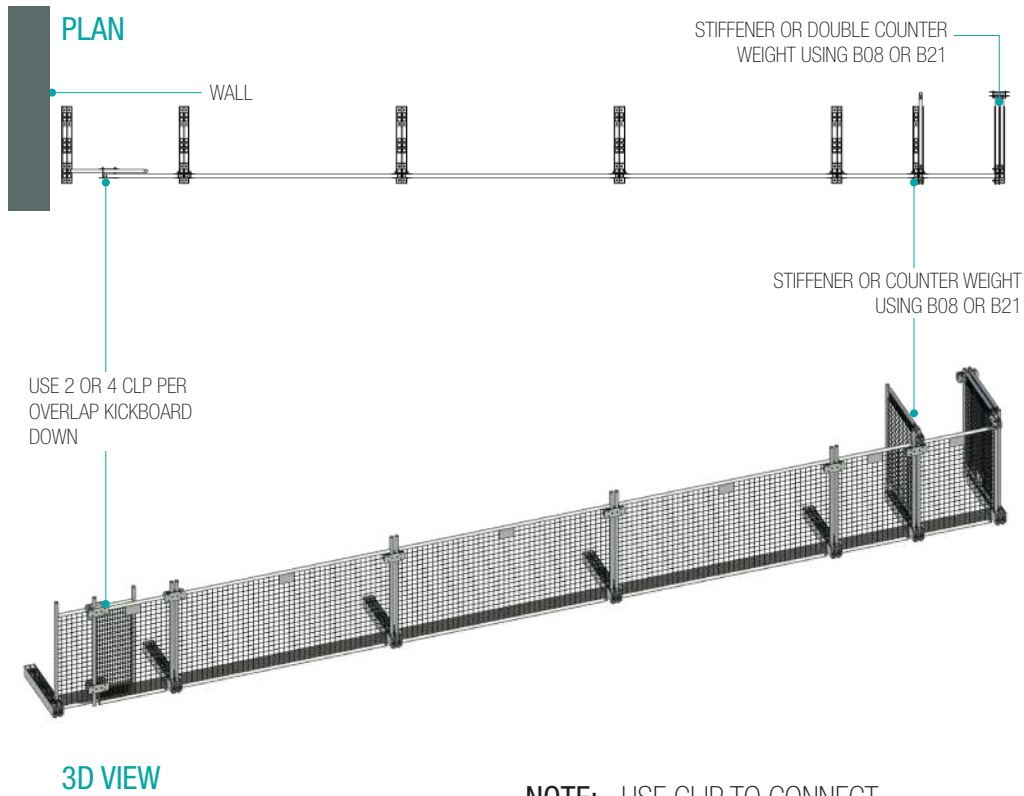

**NOTE:** USE CLIP TO CONNECT AND STIFFEN ALL VERTICAL POST CONNECTIONS

## LAYOUT 1.3

ON END OF RMB AND OVERLAP AT WALL

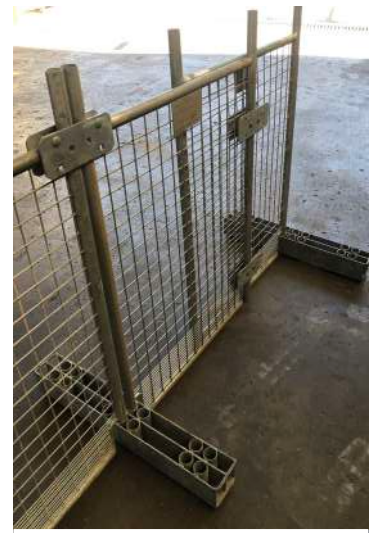
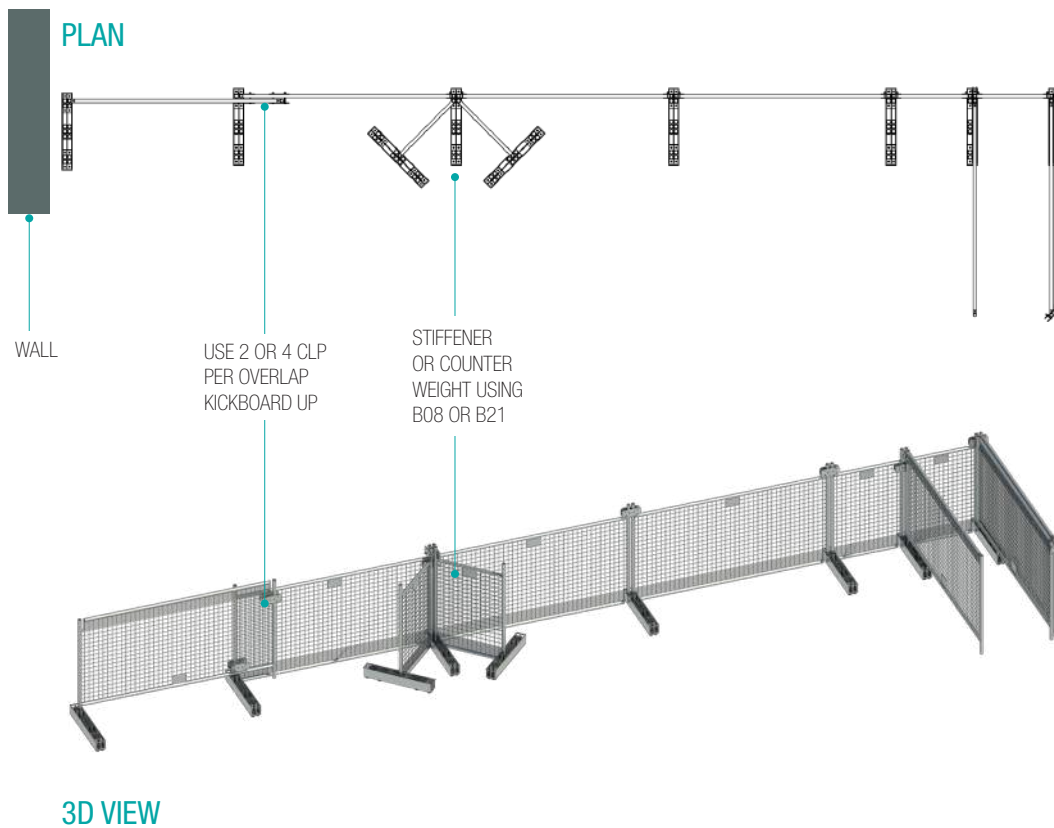



SAVE TIME  
AND  
MONEY

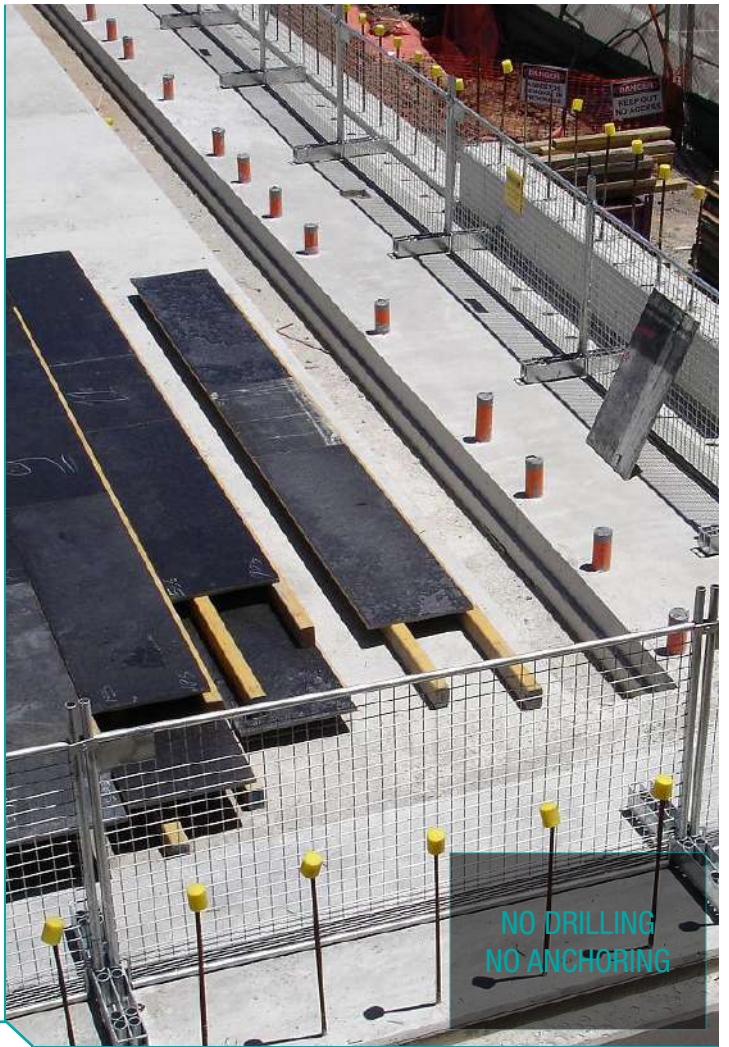

NO DRILLING  
NO ANCHORING

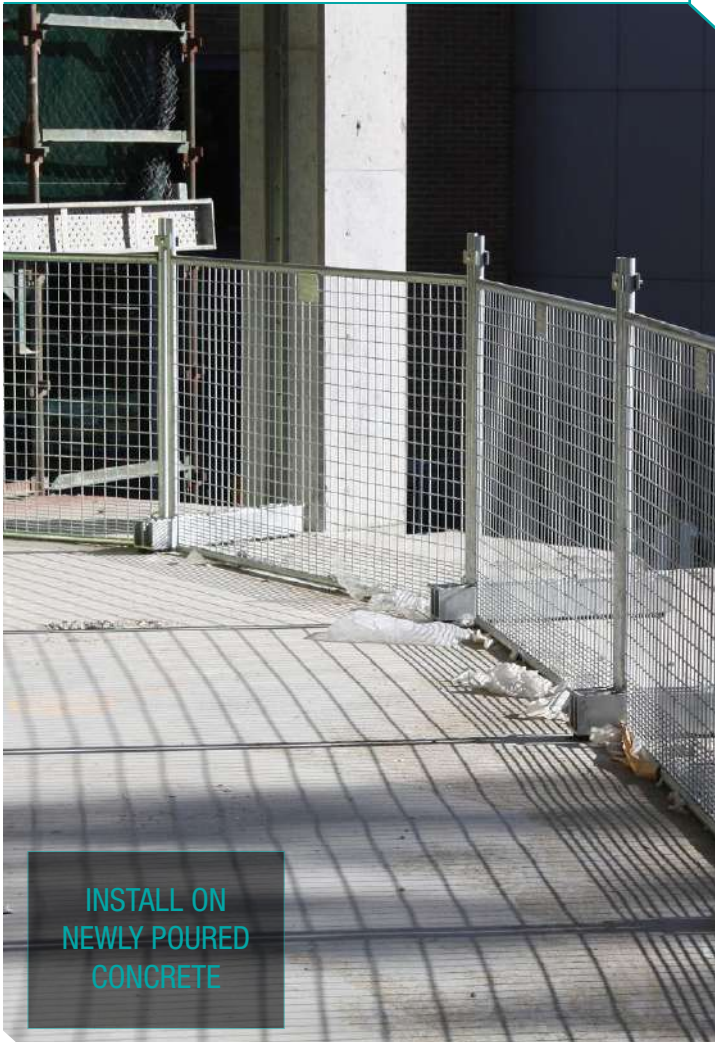

INSTALL ON  
NEWLY POURED  
CONCRETE



EASY TO INSTALL  
RELOCATE  
REMOVE





STOP OBJECTS  
FALLING FROM  
FLOOR EDGE



USE  
SUPERBARRIER  
AROUND  
PENETRATIONS



PROTECT  
WORKERS FROM  
DANGEROUS  
SITUATIONS



PROTECT  
THE  
PUBLIC



PHOTO A



PHOTO B



PHOTO C

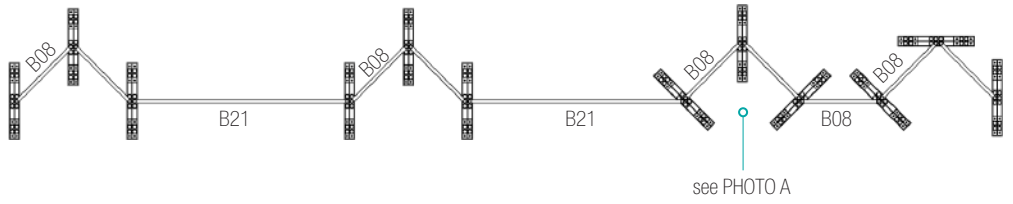

PHOTO D

THE FOLLOWING LAYOUTS ARE INDICATIVE ONLY

LAYOUT 2.1

SUPERBARRIER with B08 or B21 stiffener combination layout to prevent overturning and provide super rigidity



LAYOUT 2.2

Continuous closed barrier



LAYOUT 2.3

Continuous closed barrier

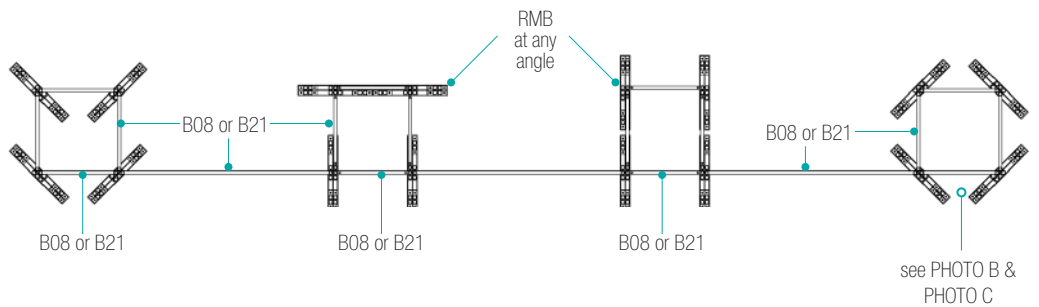

LAYOUT 3.1

PLAN - Showing overlap

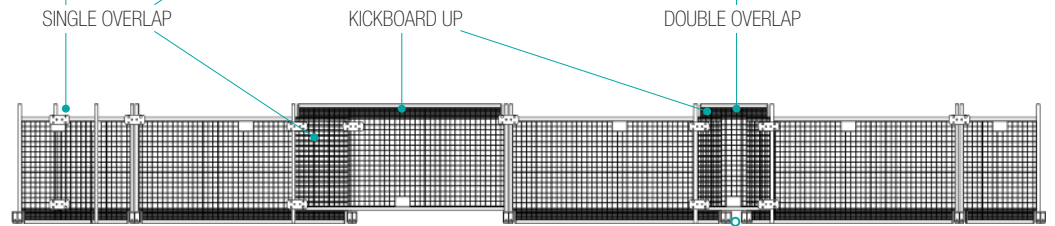

see PHOTO D

LAYOUT 3.1

ELEVATION - Showing overlap

**LAYOUT 4.1**

HEAVY DUTY DOUBLE (X2) RMB COUNTERWEIGHTS

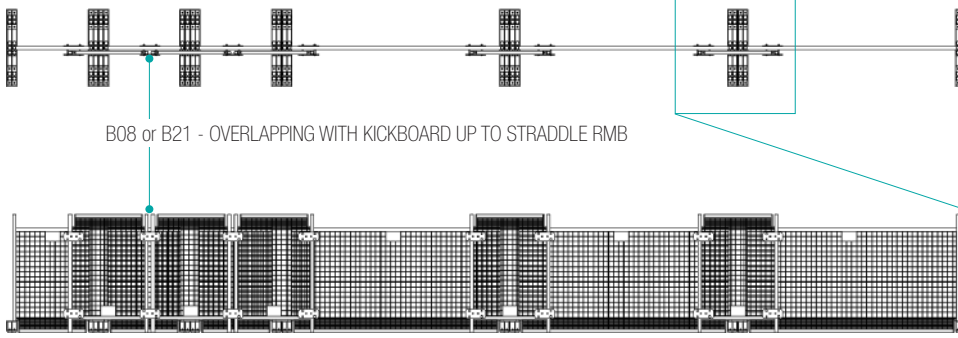

**LAYOUT 5.1**

MULTIPLE DIRECTION USE AT ANY ANGLE

**RMB HAS 14 HOLE LOCATIONS PER BASE**

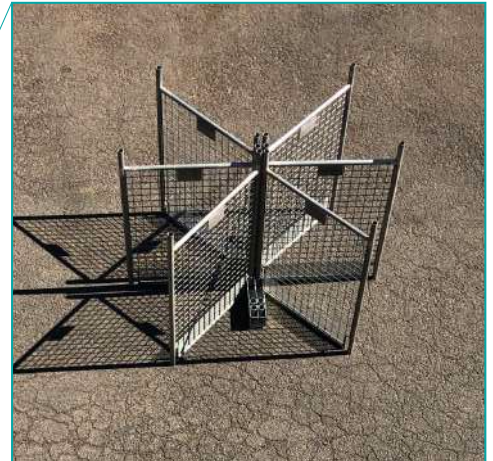
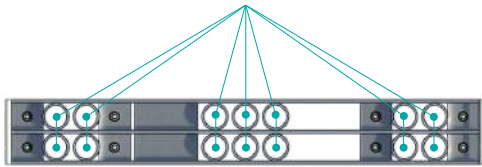

DOUBLE ROW WITH BRACE CROWD CONTROL OR EDGE PROTECTION

NO TRIPPING HAZARD CROWD CONTROL OR EDGE PROTECTION

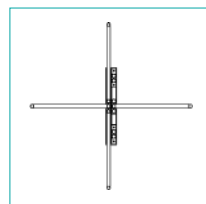
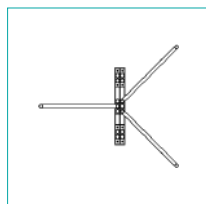
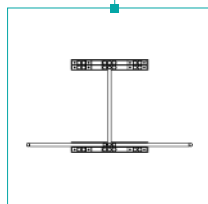
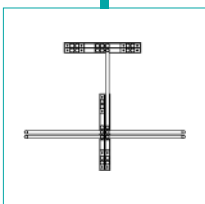
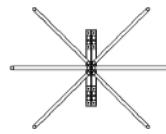

DOUBLE ROW CROWD CONTROL OR EDGE PROTECTION

TRIPLE ROW SUPER DUTY CROWD CONTROL OR EDGE PROTECTION

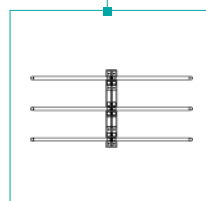
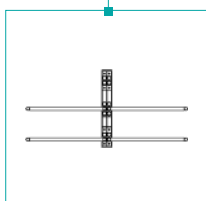

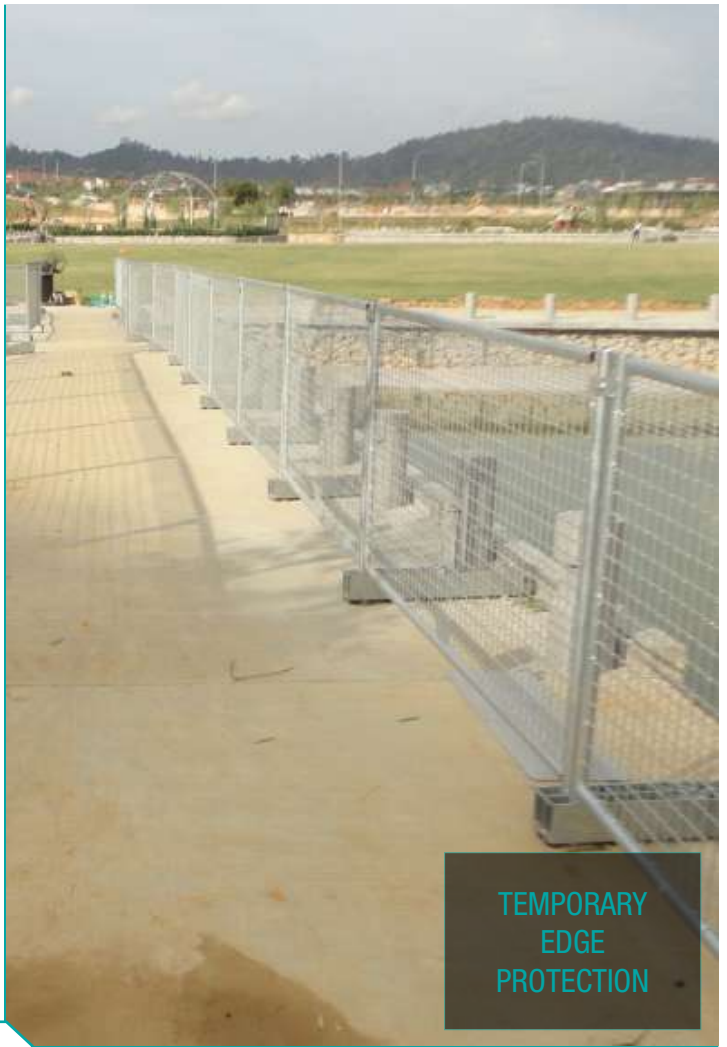

TEMPORARY  
EDGE  
PROTECTION

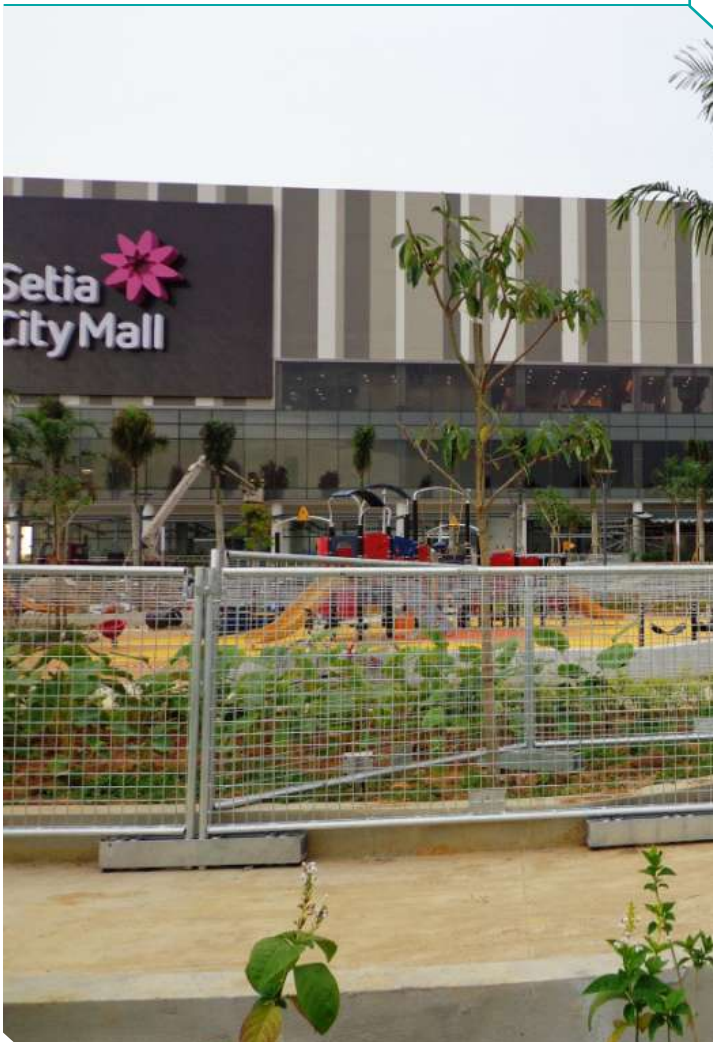

CLEAN PATH  
NO TRIP  
HAZARDS

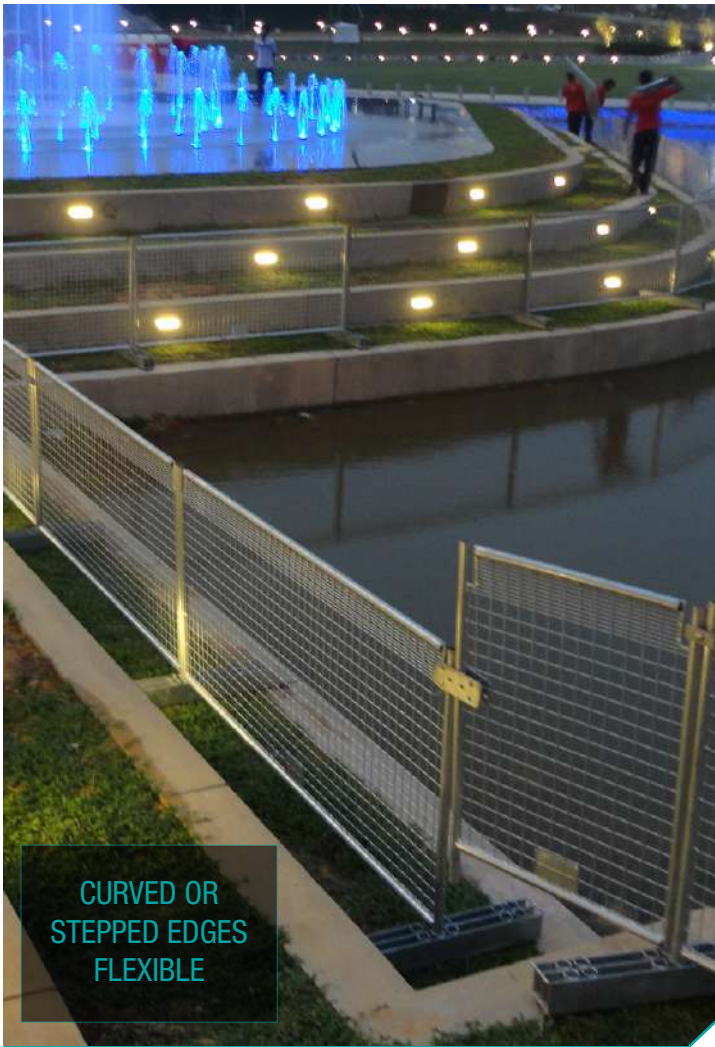

CURVED OR  
STEPPED EDGES  
FLEXIBLE

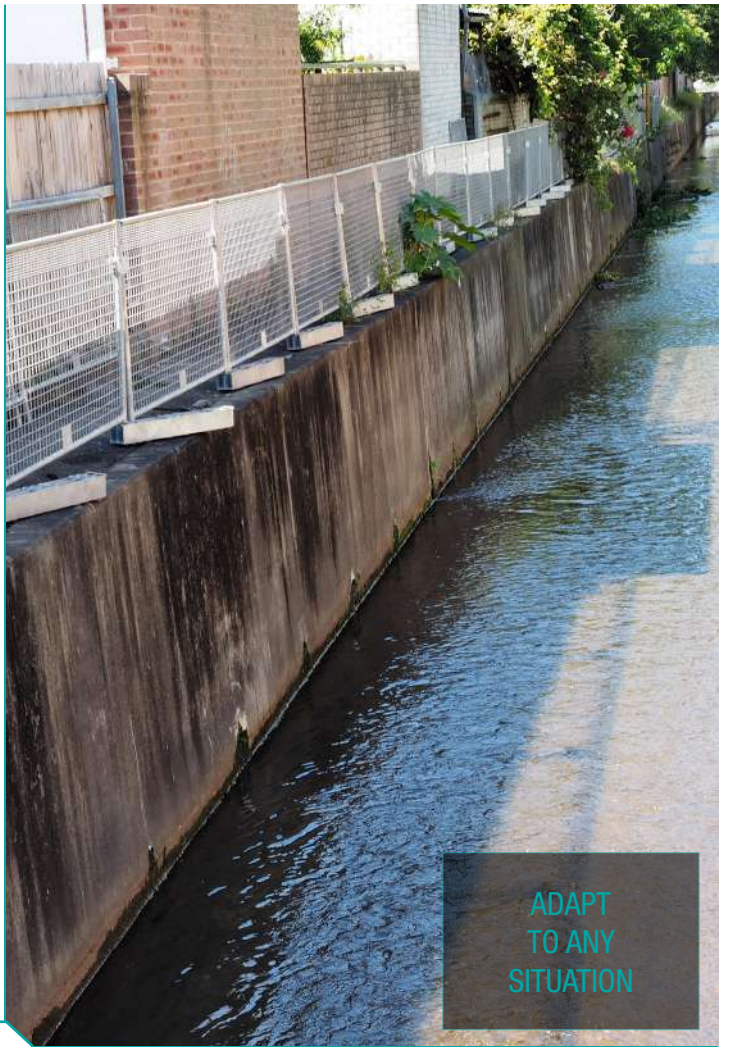

ADAPT  
TO ANY  
SITUATION



PROTECT THE  
PUBLIC FROM  
HAZARDS

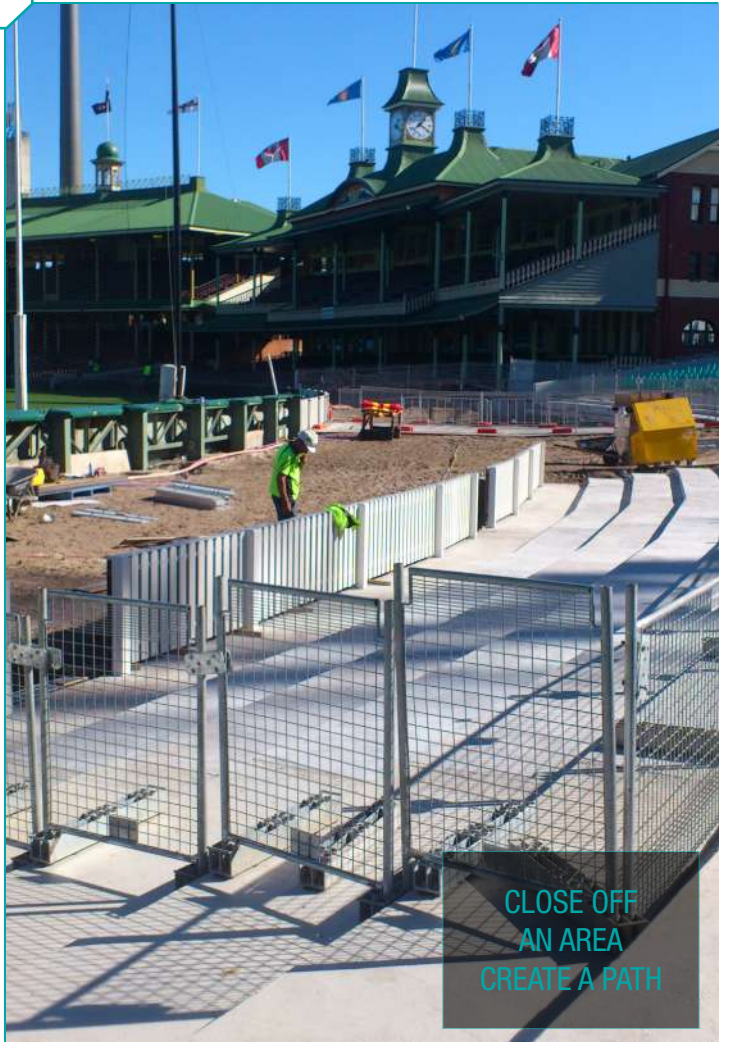

CLOSE OFF  
AN AREA  
CREATE A PATH

# BBP (BOLT DOWN BASEPLATE)

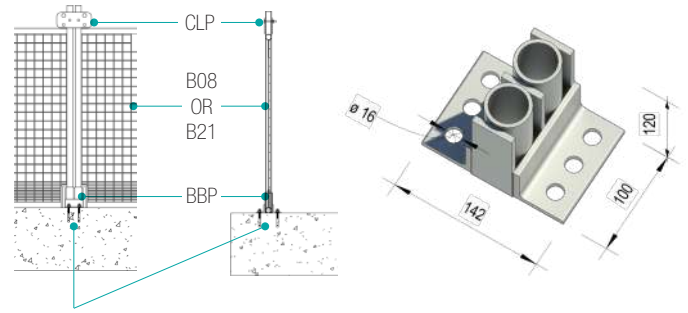
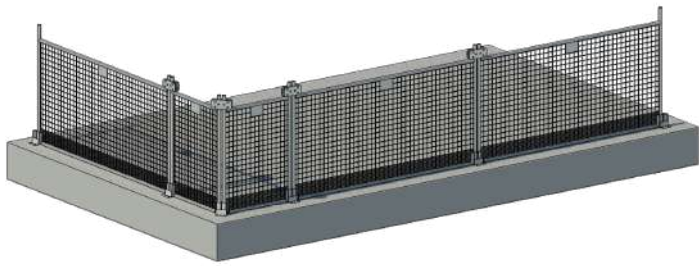

ANCHOR TO ENGINEER SPECIFICATIONS

## STANDARD LAYOUT - END OF BBP

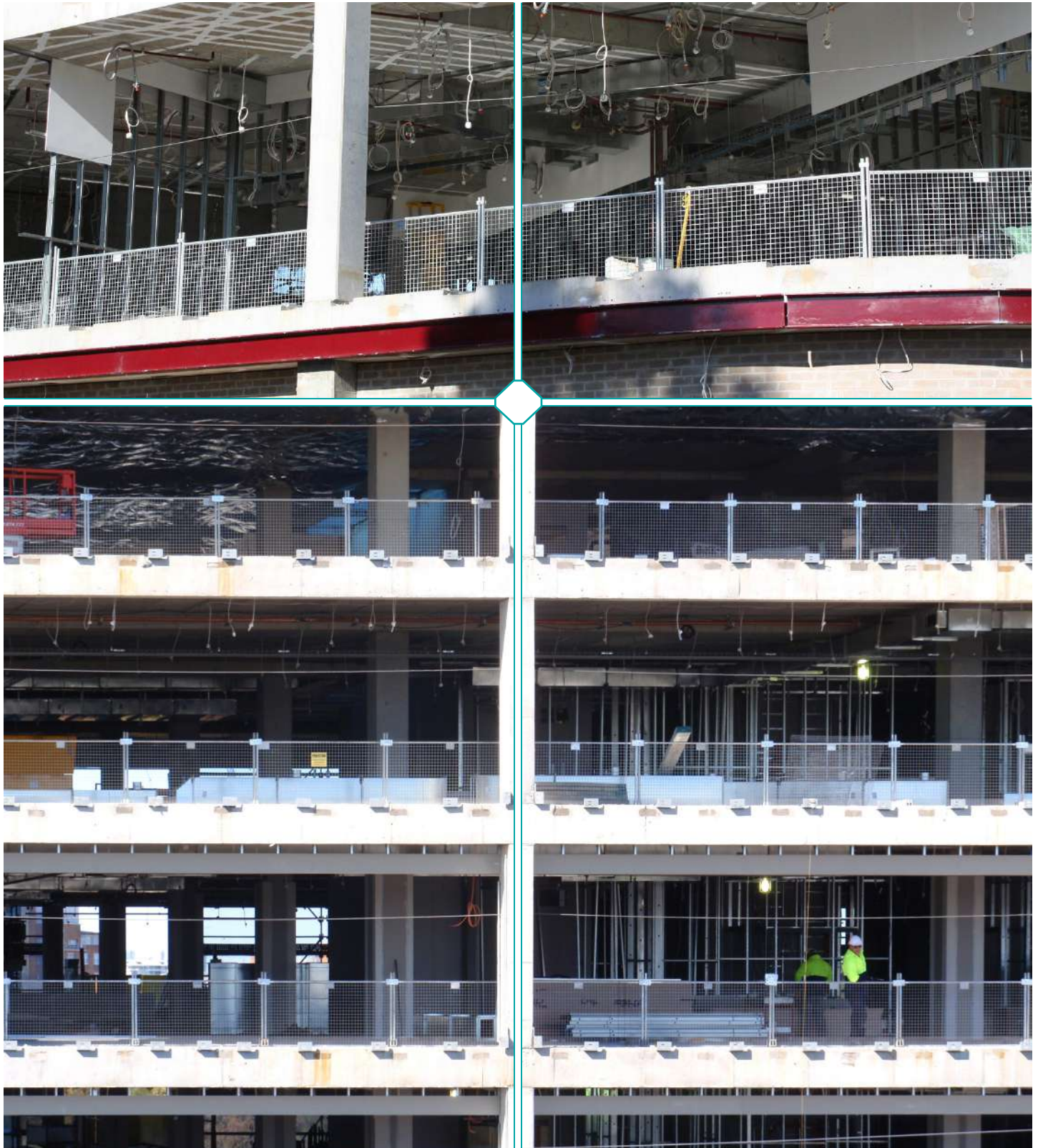



IDEAL FOR FLAT  
ROOF REPAIR,  
MAINTENANCE OR  
INSTALLATIONS



ZIG ZAG  
REINFORCING  
BARRIER WITH  
BRACING EFFECT



JUMP OVER HOBBS  
AND USE ON  
UNEVEN LEVELS



# **SpeedFence**

**EDGE PROTECTION SYSTEM**

**Patented World Wide  
Registered Design World Wide**

## **HALO SITE PROTECT**

**27-29 Fitzpatrick Street  
Revesby NSW 2212 AUSTRALIA**

**T +61 2 9772 2777 Adam +61 406 493 883 Jeff +61 410 591 910**

**[www.halositeprotect.com.au](http://www.halositeprotect.com.au)**